

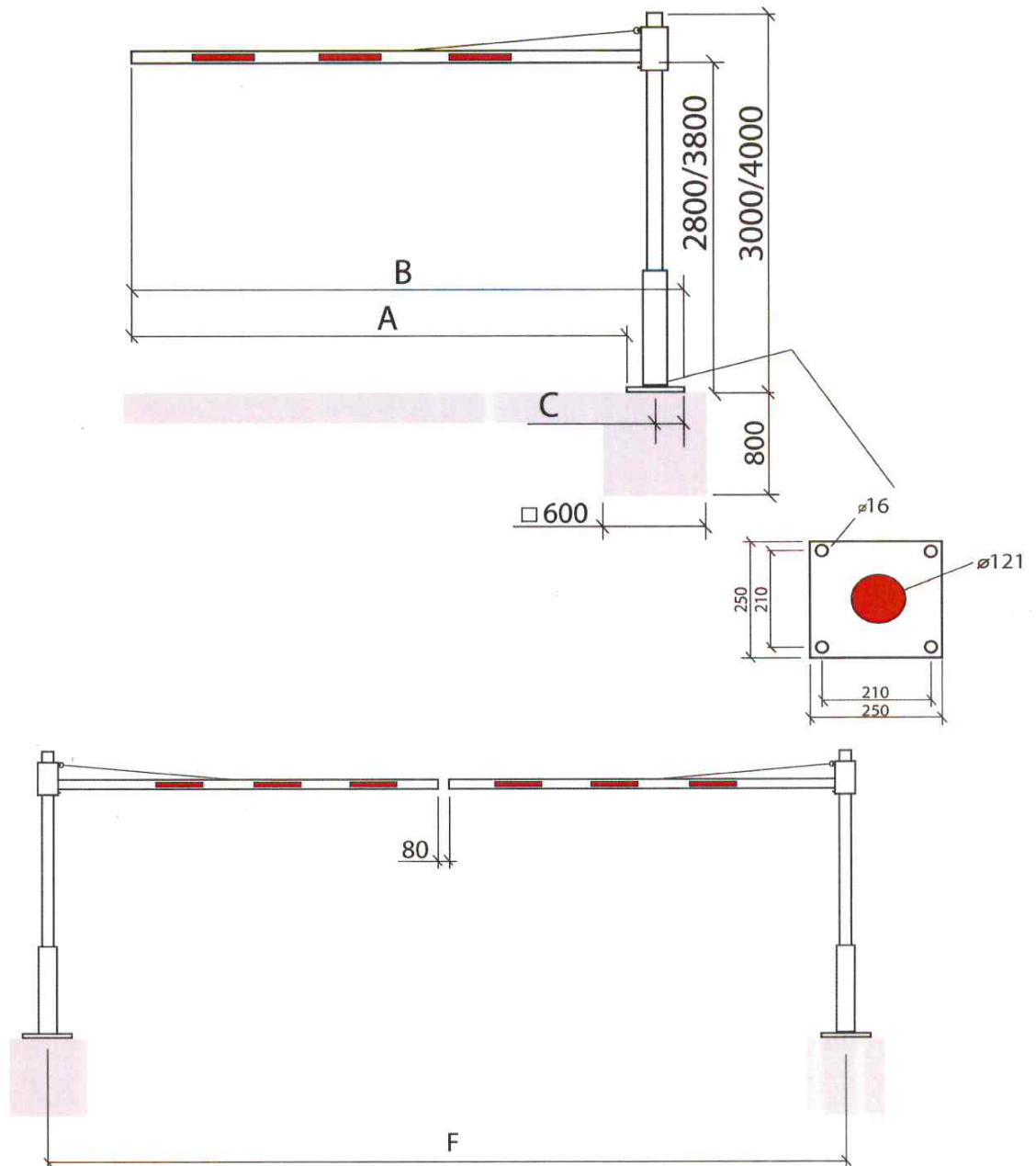

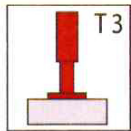

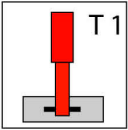

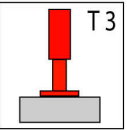

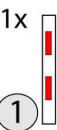
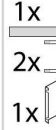



Portiques de parking pivotants avec réflecteurs rouges



A = 3437 mm
 B = 3697 mm
 C = 125 mm

D = 3457 mm
 F = 7224 mm

| | | | | | | | |
|--|--|--|--|--|--|--|--|
|  T1 |  T3 | 1x  1 | 1x  2 | 4x  5 | 1x  8 | 4x  10 |  1x |
| | | | 2x  3 | 4x  6 | | 4x  11 | |
| | | | 1x  4 | 4x  7 | 1x  9 | 4x  12 | |

